

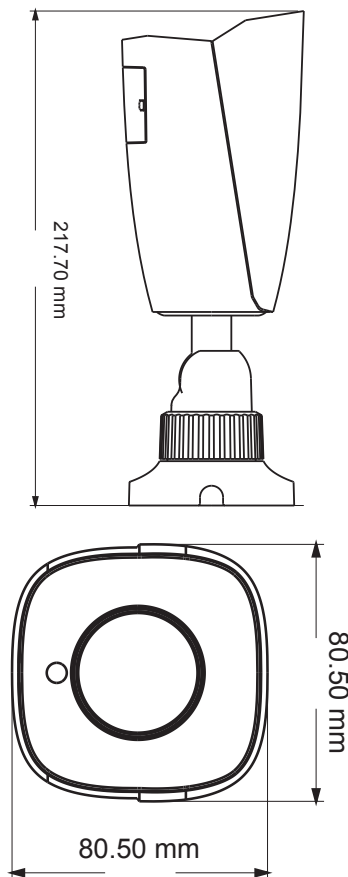

# IP CAMERA

## IPC-2T58SHG



- 2MP ( 1920 × 1080 ) H.265 full real time coding
- Max. resolution: 1920 × 1080; ICR auto switch, true day / night
- 30~ 50m IR night view distance
- Fixed, manual or motorized lens optional
- 3D DNR, Digital WDR, HLC, BLC and Defog
- ROI coding
- Hardware reset
- Built-in micro SD card slot, up to 128GB
- DC12V/PoE power supply
- Support smart phone, iPad, remote monitoring
- IP67 ingress protection
- Support dual streams







**RoHS** CE FC

# 2MP IP IR WATER-PROOF BULLET CAMERA

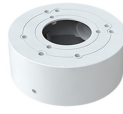

## IPC-2T58SHG

Camera	
Image Sensor	1 / 2.7 " CMOS
Image Size	1920 × 1080
Electronic Shutter	1 / 25 s ~ 1 / 100000 s
Min. Illumination	0.005 lux@F1.6,AGC ON; 0 lux with IR 0.0028 lux@F1.2,AGC ON; 0 lux with IR
Lens	EVF 2.8~12mm@F1.4 Motorized Lens
Horizontal view Angle	95.4° ~35.5°
IR Distance	30~50 m
WDR	Digital WDR
Day & Night	ICR auto switch
BLC	YES
HLC	YES
Defog	YES
Digital DNR	3D DNR
Angle Adjustment	Pan : 0° ~360° ; Tilt : 0° ~90° ; Rotation : 0° ~360°
Image	
Video Compression	H.265 / H.264 / MJPEG
H.264 Compression Standard	Baseline Profile / Main Profile / High Profile
Resolution	1080P ( 1920 × 1080 ), 720P ( 1280 × 720 ), D1, CIF, 480 × 240
Main Stream (S1)	60Hz : 1080P( 1 ~ 30fps ) / 720P( 1 ~ 30fps ) 50Hz : 1080P( 1 ~ 25fps ) / 720P( 1 ~ 25fps )
Sub Stream (S2)	60Hz : D1/CIF/480x240 (1~30fps) 50Hz : D1/CIF/480x240 (1~25fps)
Third Stream (S3)	-
Bit Rate	128 Kbps ~ 4 Mbps
Bit Rate Type	VBR / CBR
Image Settings	ROI, Saturation, Brightness, Chroma, Contrast, Wide Dynamic, Sharpen, NR, etc. adjustable through client software or web browser
ROI	Each ROI to be configured separately
Audio	
Audio Compression	G711A / U
Two-way audio	-
Interfaces	
Network	RJ45
Video Output	-
Audio line in	-
Audio line out	-
Alarm Input	-
Alarm Output	-
Storage	
SD card	Built-in micro SD card slot; up to 128GB
Network remote storage	Yes

Functions		
Remote Monitoring	Web browsing, CMS remote control	
Online Connection	Support simultaneous monitoring for up to 3 users Support multi-stream real time transmission	
Network Protocol	UDP, IPv4, IPv6, DHCP, NTP, RTSP, PPPoE, DDNS, SMTP, FTP, SNMP, HTTP, 802.1x, UPnP, HTTPS, QoS	
Interface Protocol	ONVIF, GB-T/28181-2011	
Smart Alarm	Motion detection; SD card full; SD card error	
Intelligent Analytics	-	
General function	Watermark, IP address filtering, video mask, heartbeat, password protection	
PoE	Yes	
Others		
Power Supply	DC12V / PoE	
Power Consumption	< 5W	
Operating Environment	- 30 ° C ~ 60 ° C (-22° F~140° F) Humidity: less than 95 % (non-condensing)	
Dimensions	217.7 × 80.5 × 80.5	
Weight	Approx. 640g	
Installation	Ceiling mounting; wall mounting	
Ingress Protection	IP67	
Accessories		
		
B627	B640	B639
		
B615	B616	B628